

HIBERNATE SEARCH 7

**/ Nouveautés et cas pratiques
de la recherche full-text et vectorielle Java**



Yoann Rodière

Red Hat - Hibernate Search - Quarkus



Katia Aresti

Red Hat - Infinispan - Quarkus



<https://www.youtube.com/watch?v=pQJY-Mu-yGA>

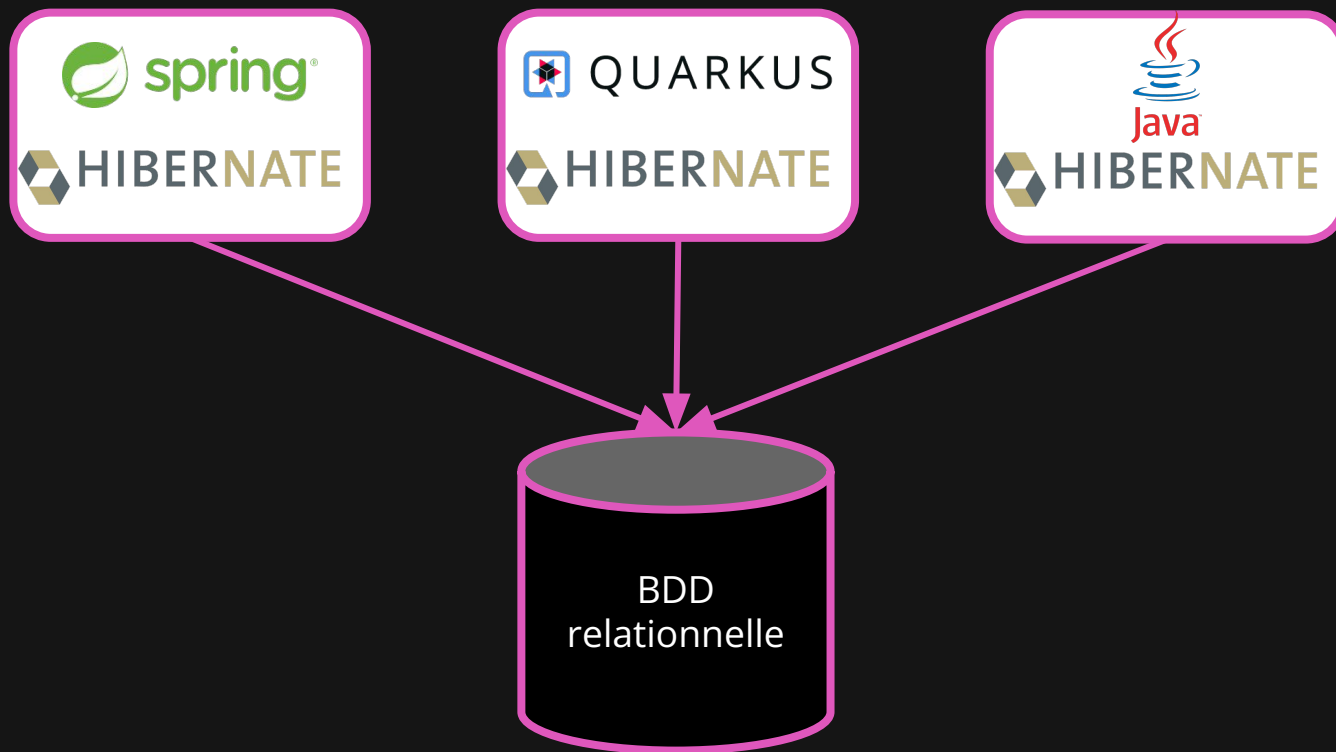

Dossier de formation

Numéro (dossier, archivage...)

Secteur d'activité



Date de modification



Date de modification



Session

Organisme de formation (nom ou numéro DA)

Type de modalité

Modalité d'exécution

Intitulé

Nature

Thème

Modalité particulière

Département

Région

Ville

Lieu

Année de début



Date de début



Date de début



Filtrer

952382 dossiers de formations trouvés

N° dossier	N° archivage	Intitulé	Situation	Stagiaires
M1337001	-	INTITULE STAGE FORMATION	Agrément	Stagiaire Nom Prénom
M1337001	-	INTITULE STAGE FORMATION	Agrément	Stagiaire Nom Prénom

Source: <https://www.kobalt.fr/clients/fafcea>

ILIKE

ILIKE '%thé%'

'kinési**thé**rapie'



ILIKE '%pommes%'

Perf



'pomme'



Tri



RECHERCHE FULL TEXT

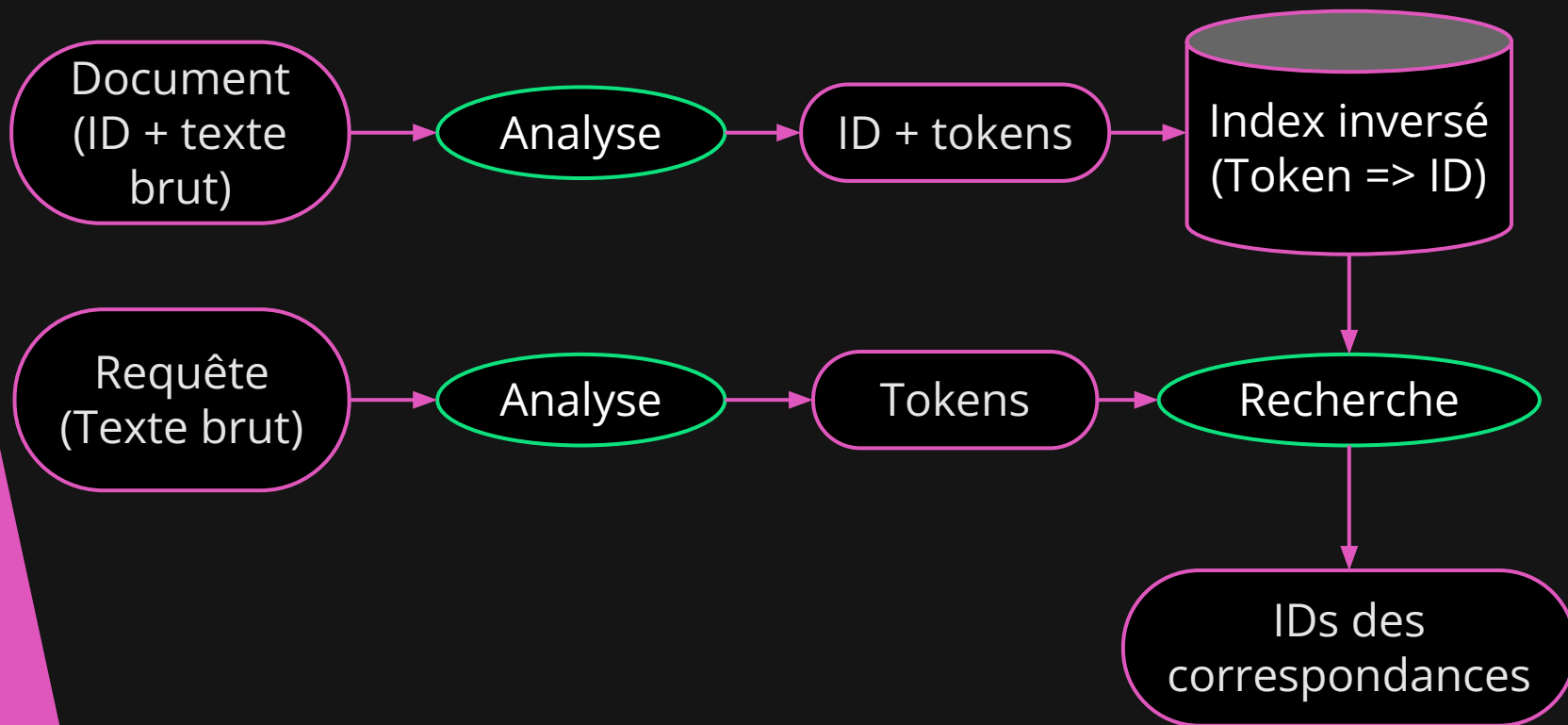

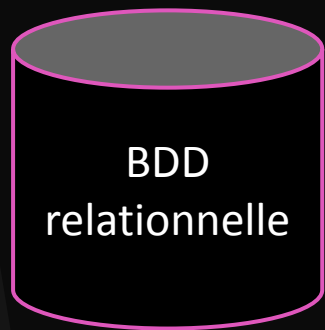

APACHE
FLUCENETM



elasticsearch



OpenSearch

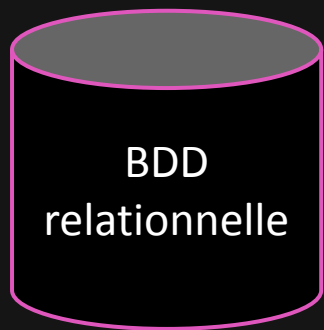



HIBERNATE SEARCH

ORM. Lucene.
Elasticsearch.
Integrated.



DÉMO

<https://github.com/yrodiere/devoxx-france-2024-hibernate-search-demo>

HIBERNATE Entités

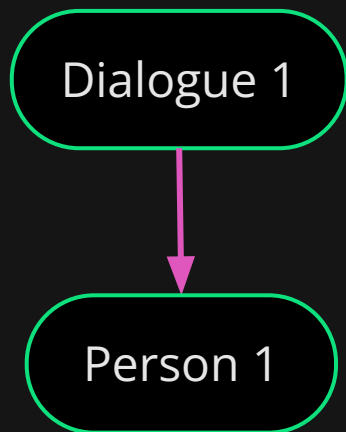

APACHE LUCENE Document

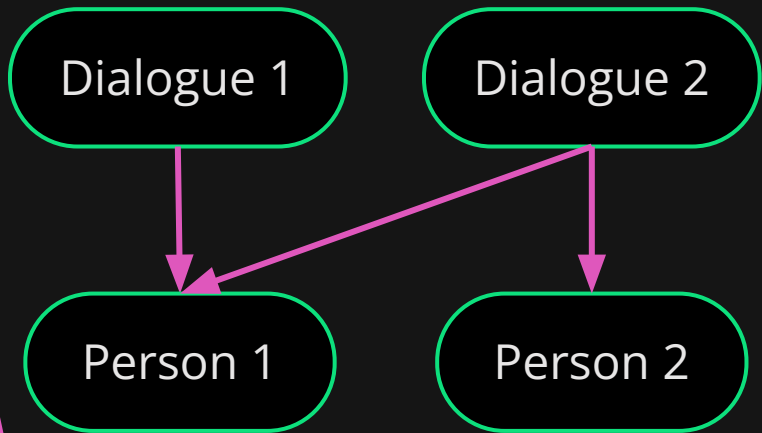
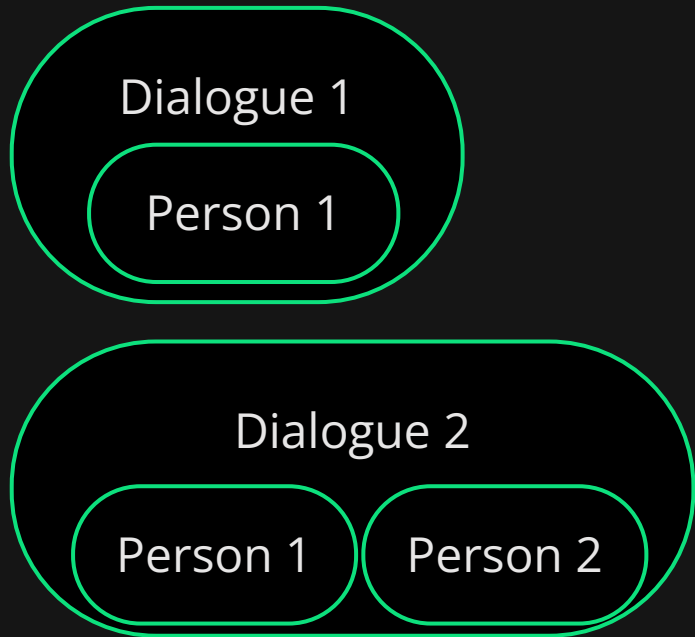

DÉNORMALISATION

 HIBERNATE Entités APACHE LUCENE Document

HIBERNATE Entités

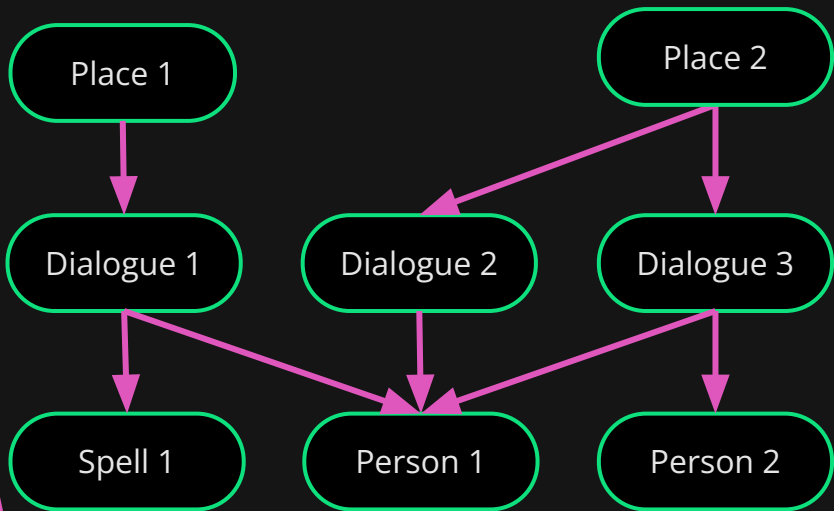

APACHE LUCENE Document



DÉNORMALISATION



INDEXATION

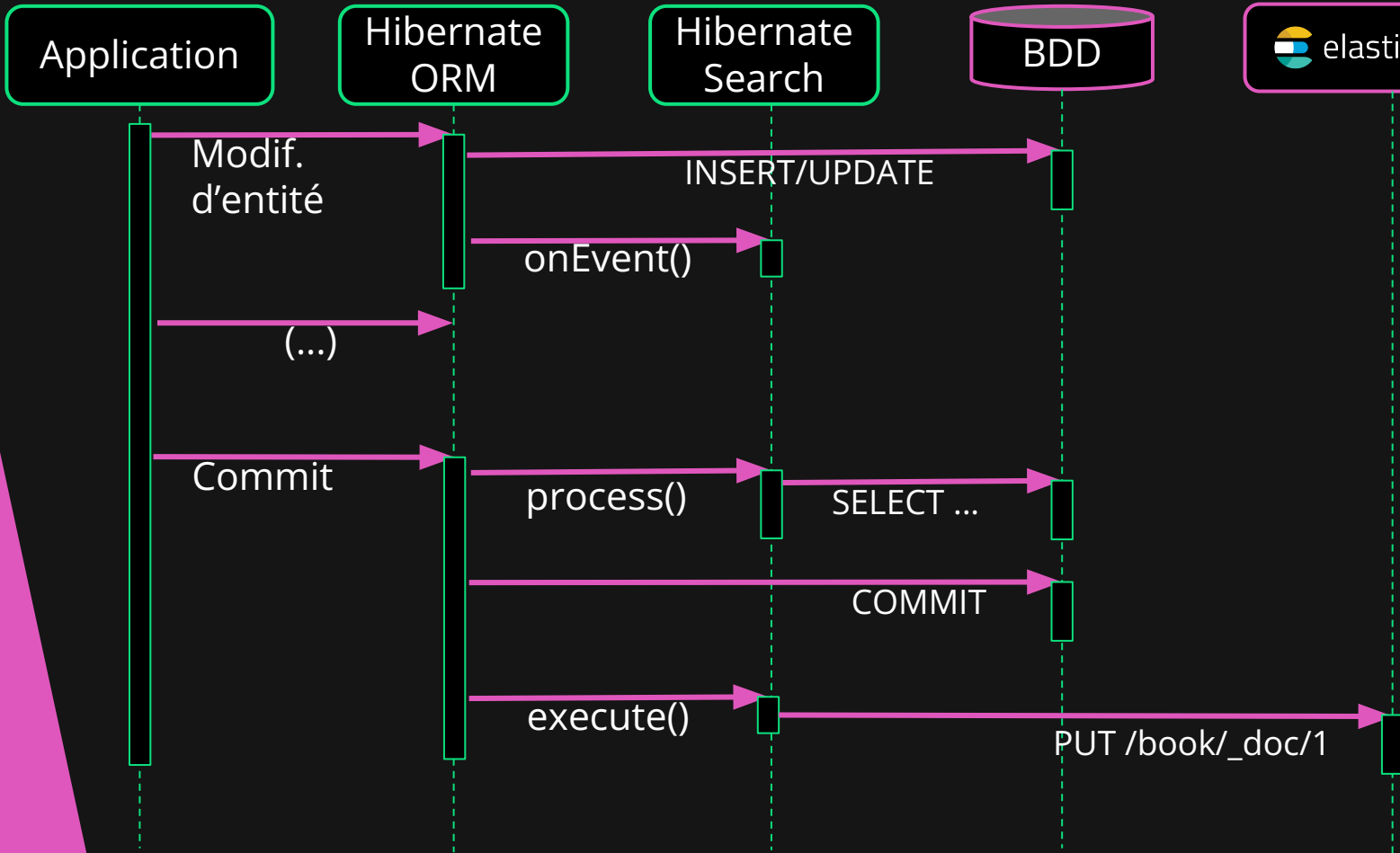



HIBERNATE SEARCH

VERSION 6+
2020

REFONTE API



GÉNÉRIQUE

CONCIS

CUSTOMISABLE

ÉPROUVÉ

REFONTE API



TRANSACTIONS ?

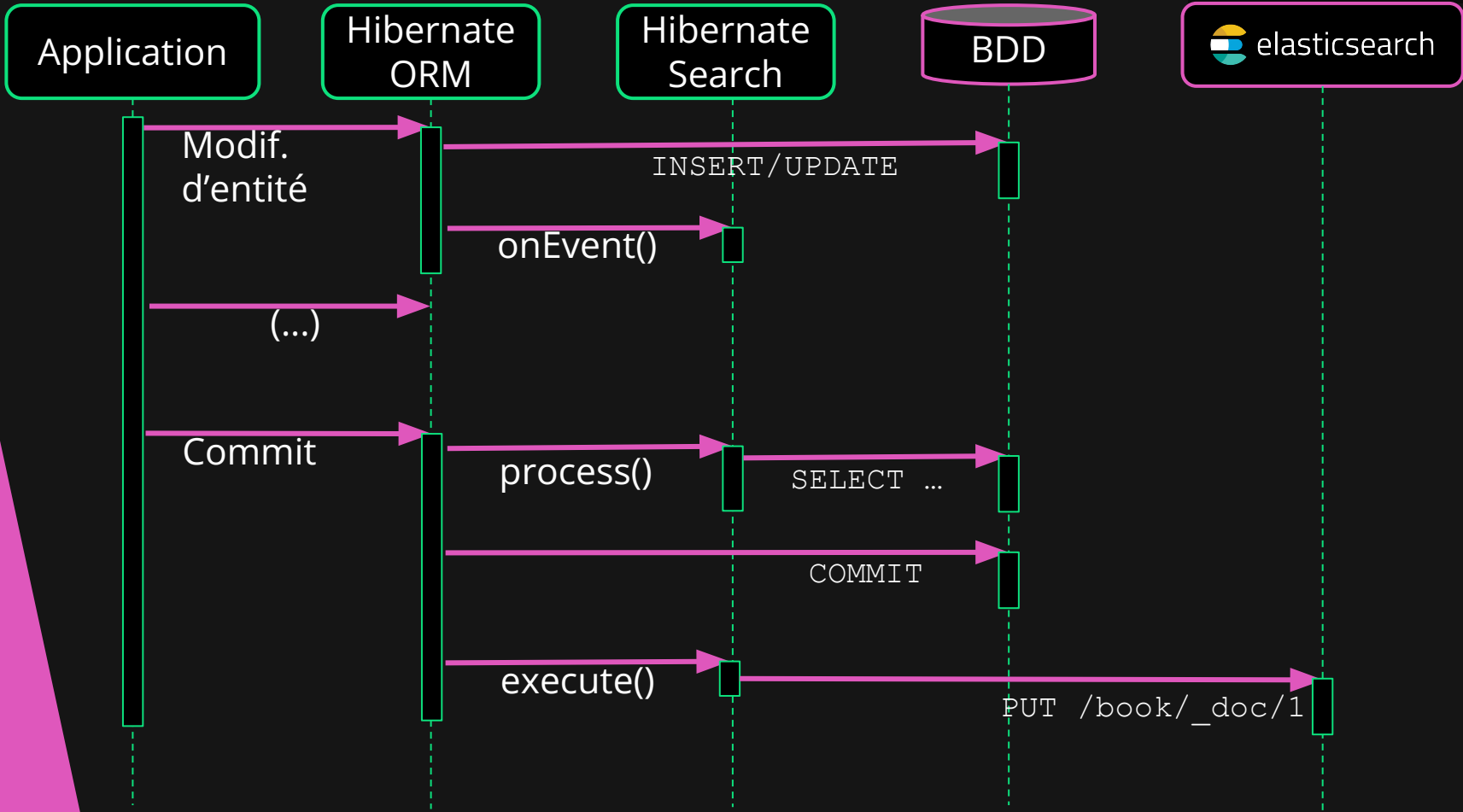



TRANSACTIONAL OUTBOX

https://docs.jboss.org/hibernate/stable/search/reference/en-US/html_single/#coordination-database-polling



TRANSACTIONAL
OUTBOX 1

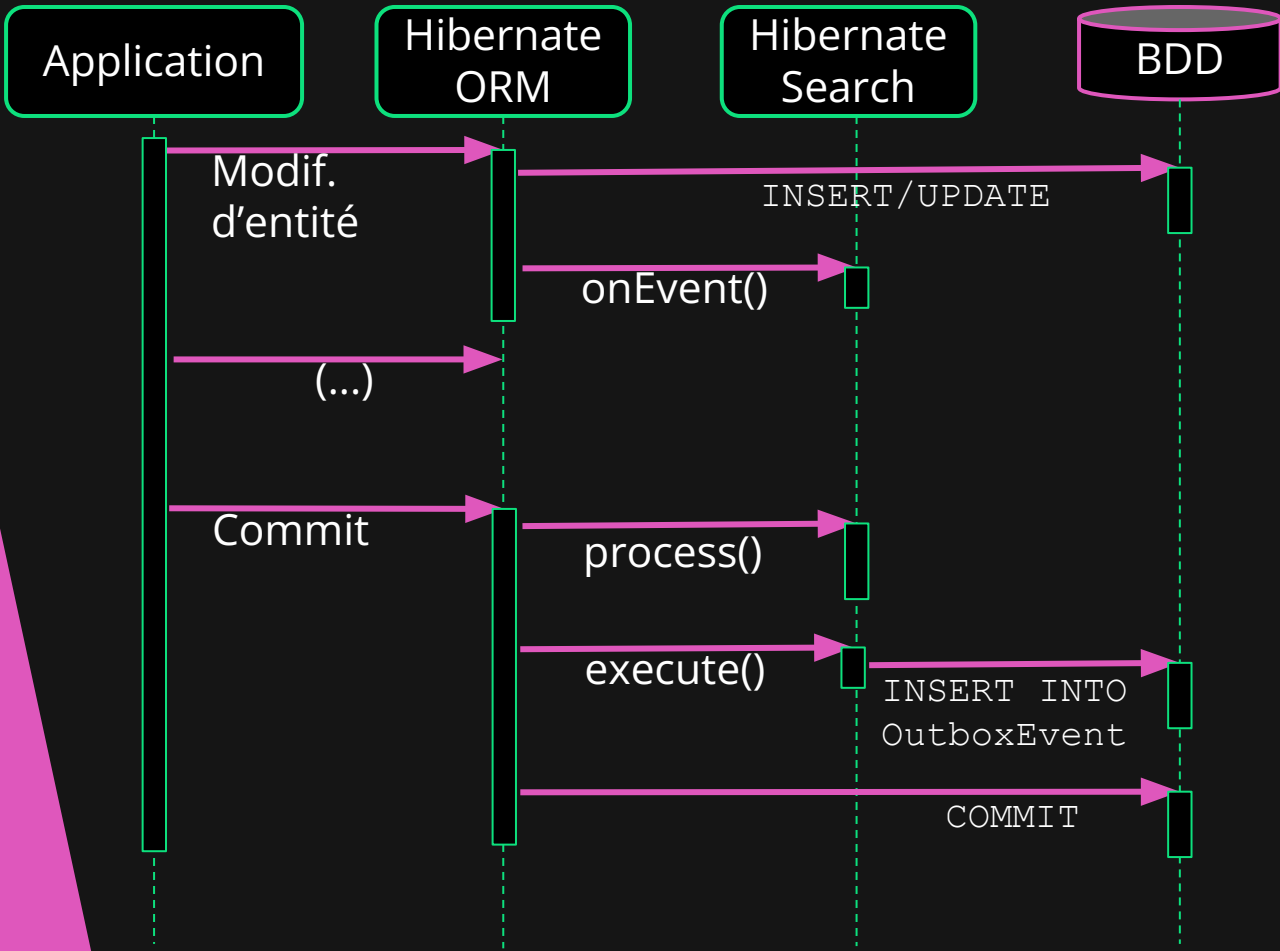

TRANSACTIONAL
OUTBOX 2

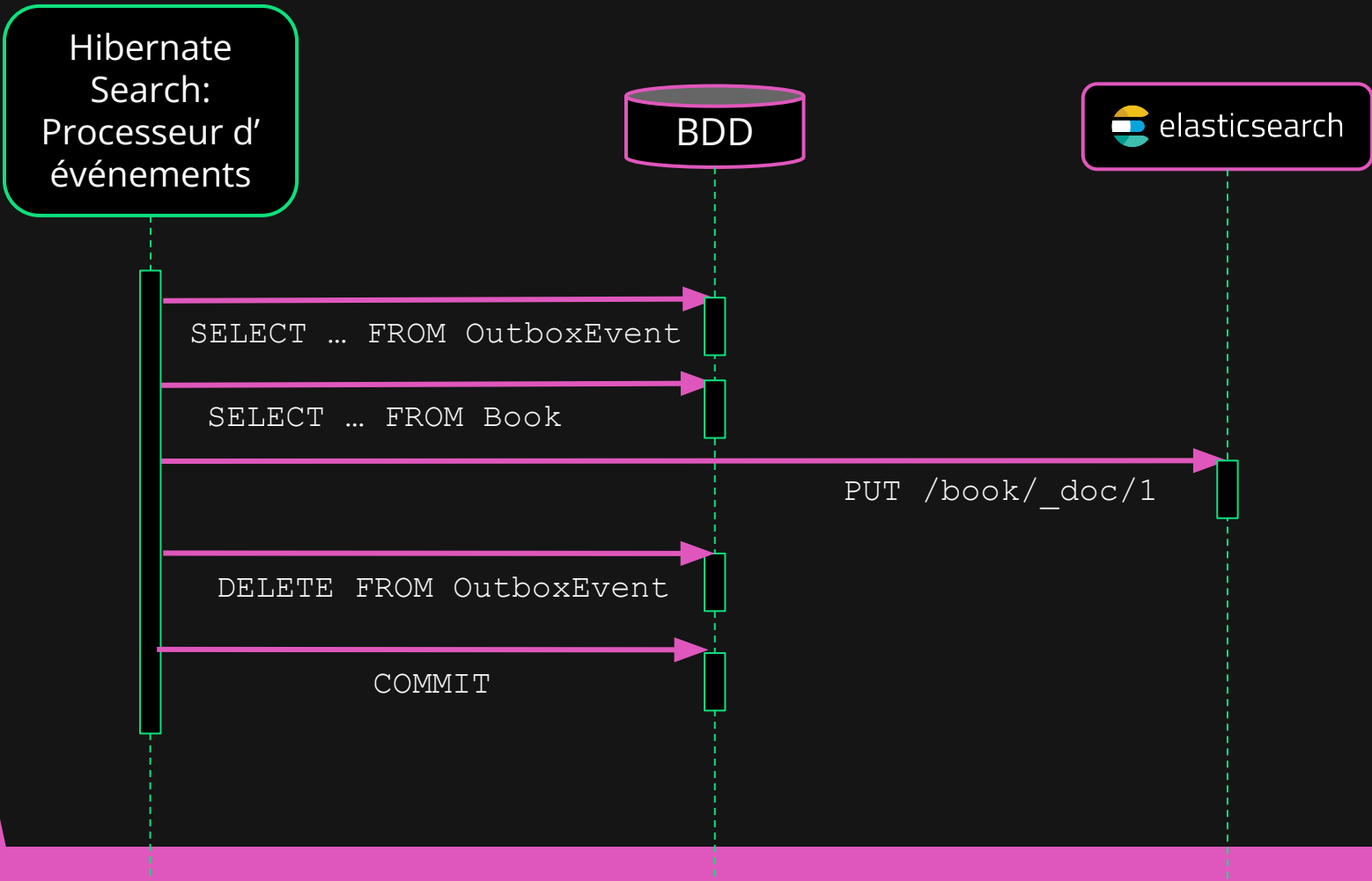

TRANSACTIONNEL

Perte d'événement impossible



**PLUS
PUISSANT...**

ASYNCHRONE

Latence minimale

PARTITIONNÉ

Pas de conflits d'indexation
Parallélisme



Infrastructure :

Application

+

BDD

+

 elasticsearch

Configuration :

```
<dependency>
  <groupId>io.quarkus</groupId>
  <artifactId>
    quarkus-hibernate-search-orm-outbox-polling
  </artifactId>
</dependency>
```

```
quarkus.hibernate-search-orm.coordination.strategy
=outbox-polling
```

... ET TOUT
AUSSI SIMPLE



STANDALONE POJO MAPPER

https://docs.jboss.org/hibernate/stable/search/getting-started/standalone/en-US/html_single/index.html#mapper-pojo-standalone-getting-started

STANDALONE POJO
MAPPER

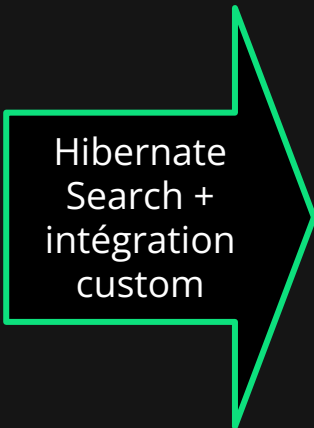

INFINISPAN

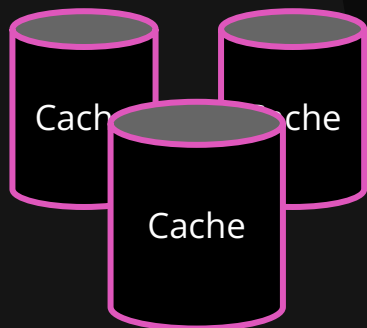

Hibernate Search +
intégration custom

APACHE
LUCENE™



Infinispan

<https://infinispan.org/>

<https://infinispan.org/docs/stable/titles/query/query.html>

INFINISPAN EMBEDDING STORE



Infinispan



Lanchain 4J



LangChain



HIBERNATE SEARCH

VERSION 7
2023 / 2024

VECTEURS ET EMBEDDINGS

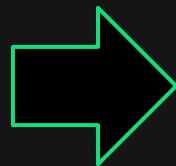
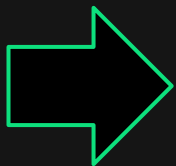

```
[ -0.7754,  
  -0.7972,  
  -0.5784,  
    ...  
  -0.4750,  
  -0.4254 ]
```

RECHERCHE
VECTORIELLE

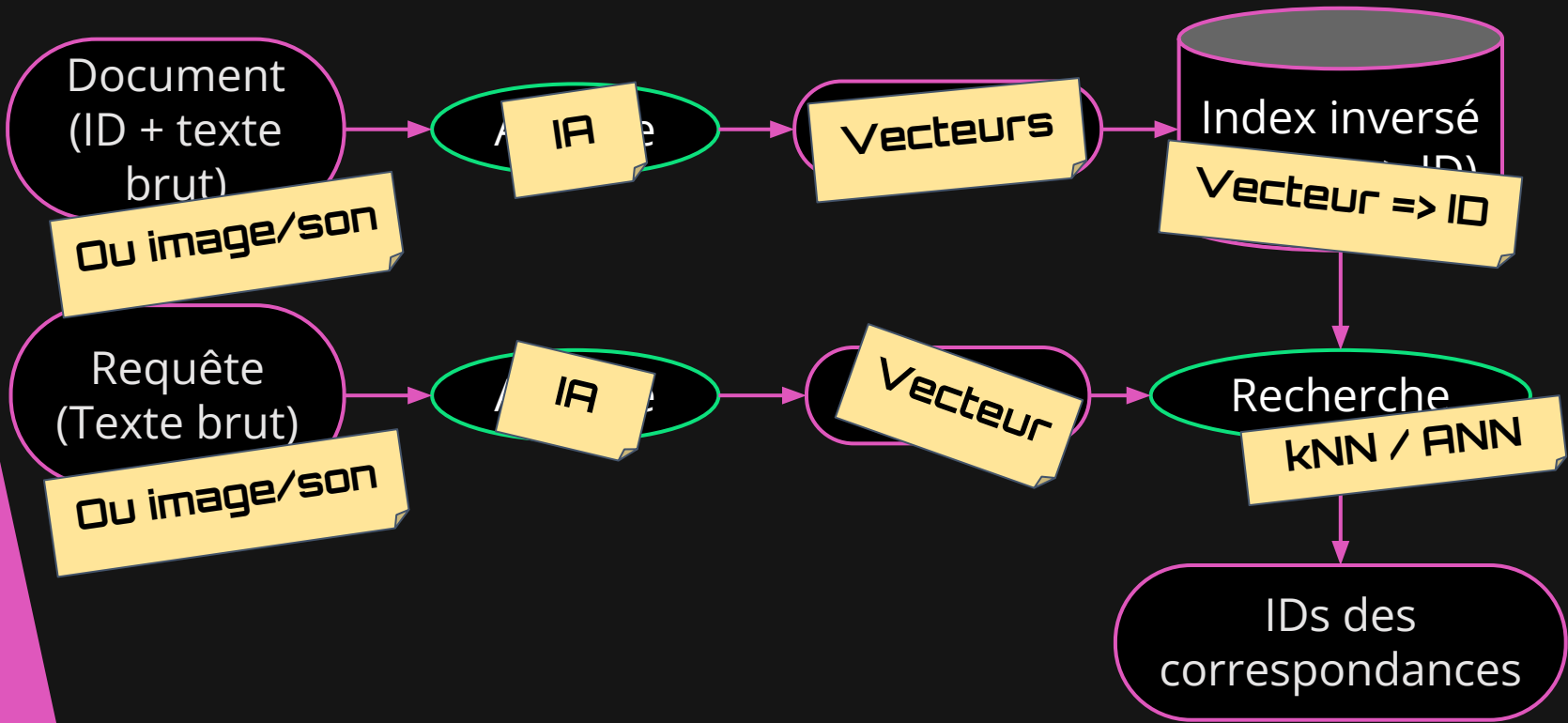



DÉMO

<https://github.com/yrodiere/devoxx-france-2024-hibernate-search-demo>

WHEN A USER TAKES A PHOTO,
THE APP SHOULD CHECK WHETHER
THEY'RE IN A NATIONAL PARK...

SURE, EASY GIS LOOKUP.
GIMME A FEW HOURS.

... AND CHECK WHETHER
THE PHOTO IS OF A BIRD.

I'LL NEED A RESEARCH
TEAM AND FIVE YEARS.



STAY TUNED

<https://xkcd.com/1425/>

This work is licensed under a [Creative Commons Attribution-NonCommercial 2.5 License](#).

MERCI !



<https://quarkus.io/>



<https://hibernate.org/search/>



**ALLER PLUS
LOIN**

DEVOXX^{FR} FRANCE

La recherche à l'ère de l'IA *par David Pilato (Elastic)*

La recherche sous stéroïdes - une histoire de sémantique
par Mathilde Rigabert et Martin Labenne (Jolimoi)

**Apache Lucene : de l'indexation textuelle à l'intelligence
artificielle** *par Lucian Precup (Adelan)*

... et encore plus

Analyse

